

TARVIKKEET TYÖSTÖKONEISIIN

AVAINKIRISTEISET ISTUKAT

- B16/1-13mm
- B18/3-16mm



IRTOKARAT

- Mk1/B16
- Mk2/B16
- Mk2/B18
- Mk3/B16
- Mk3/B18
- Mk4/B18



PYÖRIVÄT KESKIÖKÄRJET

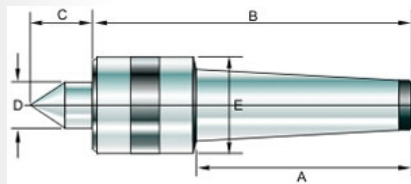

SOBA	A	B	C	D	Max rpm	Paino	Koodi	Sarake1
MK2	69	109	27	18	1500	0,5	201507	
MK3	86	146	34	24	1500	1,3	201512	
MK4	109	179	37	28	1200	2,1	201517	



PC	A	B	C	D	Max rpm	Paino	Koodi	Sarake1
MK2	69	132	26	22	3500	0,42	KÄRKIMK2TW	
MK3	86	164	32	26	3000	0,76	KÄRKIMK3TW	
MK4	108	188	34	30	2500	1,22	KÄRKIMK4TW	

PYÖRIVÄ KESKIÖKÄRKI

- vaihtokärjellä, 7 kpl
 - 5-31mm
 - Mk2
 - Mk3
- K:201610 ja 201620



PIKAISTUKAT

- tarkkuusluokka 0,14mm
- B16/1-16mm, Yama
- B18/1-16mm, Yama
- tarkkuusluokka 0,08mm
- B16/1-13mm
- B16/1-16mm
- B18/3-16mm



VÄHENNYSHOLKIT

- Mk2/Mk1
- Mk3/Mk2
- Mk3/Mk1
- Mk4/Mk3
- Mk4/Mk2



SUURENNUSHOLKIT

- Mk3/Mk4
- Mk2/Mk3



NELILEUKAISTUKKA

- 65mm
- itsekeskittävä
- M12x1,0
- MT2 karalla (pyörivä)
- K:146216



KOLME- JA NELILEUKAISTUKAT

- laippakiinnitys
- 3l. itsekeskittävä ja 4l. erikseen säädettävät leuat

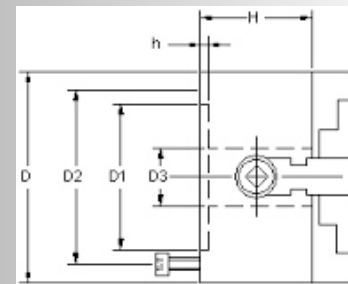

3 LEUKA	D	D1	D2	D3	H
125mm	125	95	108	30	78
160mm	160	130	142	45	95
200mm	200	165	180	65	109
250mm	250	206	226	80	120

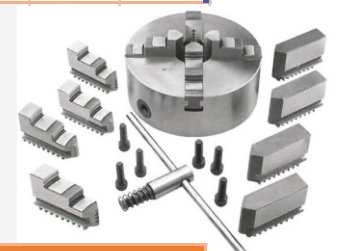

4 LEUKA	D	D1	D2	D3	H
125mm	125	95	108	30	78
160mm	160	130	145	40	96,5
200mm	200	125	104,8	50	110
250mm	250	100	120	65	117,5

PIKAVAIHTOTERÄPIDIN

- 5:llä pitimellä (16-20mm terävarsille)
- istukan koko 80x80x90mm
- vakiona 16mm pitimet
- K:CZ-300PV

Pidin ed. 16/20mm

**PIKAVAIHTOTERÄPIDIN**

- malli Multifix, 4:llä pitimellä
- 9 asteen kääntökulmalla
- Tyyppi A0, teräkork. 12mm
- Tyyppi A1, teräkork. 16/20mm
- Tyyppi E, teräkork. 20/25mm
- Tyyppi B, teräkork. 25/32mm

**TUKILAAKERIT**

- BB-25 sarja
- BB-32 sarja
- BL sarja

**LEIKKUUNESTE**

- puolisyntheettinen
- käytetään 3-8%:n liuksena
- teräksen ja alumiinin työstöön
- 1L
- 5L

**KONESYÖTÖT RISTISYÖTTÖ-PÖYTÄÄN**

- 230V/110V
- portaaton syötön säätö
- rajakytkimellä
- pikaliikkeellä
- vaaka/pystyversio
- K:RF-KONES

**NESTESYÖTTÖLAITTEISTO**

- 230V/50Hz tai 400V/50Hz, 1/8 hp
- säiliö 7,5l, letkusto, pumppu, kytkimet
- K:RF-PUMP ja RF-PUMP230

**KONEENALUSKENGÄT**

- 10mm/100mm
- halk. 60mm
- maks. kuorma 100kg/kenkä

- 12mm/115mm
- halk. 70mm
- maks. kuorma 150kg/kenkä

- 12mm/70mm
- halk. 140mm
- maks. kuorma 1000kg

- 12mm/110mm
- halk. 105mm
- maks. kuorma 1000kg

- 16mm/150mm
- halk. 80mm
- maks. kuorma 1000kg



JAKOLAITE

- jakolevyillä (jaot 2,3,4,6,8,12 ja 24)
- istukalla (BS 0 100mm, BS 1 130mm)
- keskiökärjellä.

tyyppi	BS 0	BS 1
korkeus	173mm	220mm
kärkikorkeus	100mm	128mm
paino	19 kg	35 kg

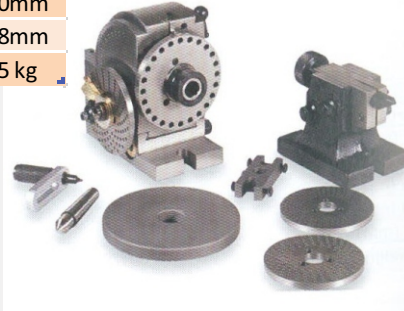
**PYÖRÖPÖYTÄ HV**

- pysty- ja vaakamalli
- jako 1:90
- asteikko 360
- asteikko asteittain, nonius 10

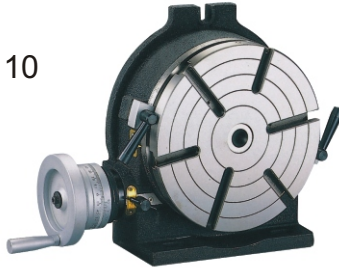
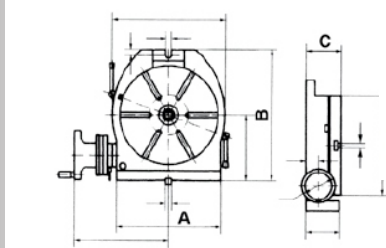

Tyyppi	A	B	C	Kartio	Paino
HV-6	195	200	82	2	12
HV-8	220	265	106	3	30
HV-10	280	322	115	3	48

PYÖRÖPÖYDÄT GLANZE

- pysty- ja vaakamalli
- jako 1:90
- asteikko 360
- asteikko asteittain



110240



110239



110305

Tyyppi	Pöytä	Korkeus	T-ura	Jako	Paino
110239	110	75	10,5	90:1	8,5
110240	100	55	8,1	36:1	5,7
111305	100	63	7,7	36:1	6,5



- jakolevysrj. lisävarusteena 110239
- vastakärki lisävarusteena 110239, 11240 ja 110305

KIINNITYSISTUKKASARJA

- Mk2, holkit 4,5,6,8,10,12,14 ja 16mm, Er25
 - Mk3, holkit 4,5,6,8,10,12,14 ja 16mm, ER25
 - Mk3, holkit 4,6,8,10,12,16 ja 20mm, ER32
 - Mk4, holkit 4,6,8,10,12,14,16,20 ja 25mm, ER40
- K:KIINISSRJkoko

**KIINNITYSRAUTASARJA**

- 52 os.
 - 10mm T-urille (M8)
 - 12mm T-urille (M10)
 - 14mm T-urille (M12)
 - 16mm T-urille (M14)
- K:KIINRSRJkoko

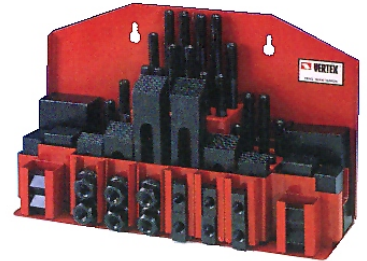
**T-URAMUTTERIT**

- M10/12mm K:3205010012
- M12/14mm K:3205012014
- M12/16mm K:3205012016
- M12/18mm K:3205012018

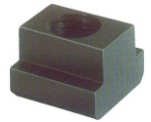
**OLAKEMUTTERIT**

- M10 K:3204910015
- M12 K:3204912018

**RUUVIT**

- M10/50mm K:3204510050
- M12/63mm K:3204512060



SUOJALAITTEET TYÖSTÖKONEISIIN

HEC®

KARAN LASTUSUOJAT

- mikrokytkimellä
 - ruuvikiinnitteinen
 - muovirungolla/alum. varsi
 - korkeussäätö 230mm
 - suojan halkaisija 125mm
 - suojan korkeus 150mm
- K:VOHU-SUOJA



- mikrokytkimellä
 - ruuvikiinnitteinen
 - metallirungolla
 - korkeussäätö 140mm
 - suoja 208x410x5mm
 - suoja 208x530x5mm
- K:32105A ja 32107A

FREJOTH



- mikrokytkimellä
 - suojavaari polykarbonaattia
 - ruuvikiinnitteinen
 - metallirungolla
 - kaarena MT/300-MT/400
- K:RP



HIOMAKONEEN SUOJA

- iskunkestävää polykarbonaattia
- metalliraamit
- mallit DM/1 (150x150mm) ja DM/2 (210x210mm)



SUOJALAITTEET TYÖSTÖKONEISIIN



KARASUOJA JYRSINKONEISIIN

- kahdella (SF) tai kolmella (SF-Special) rajakytkimellä
 - polykarbonaattisuojaalla
 - metallirungolla
 - kaasujousi suojakaarelle (SF-Special)
 - mallit oikea ja vasen
- K:SF ja SF-Special

Koodi	D	G	L
SF/300	300	415	240
SF/350	350	415	240
SF/400	400	415	240
SF/450	450	415	240
SF/500	500	415	240
SF/600	600	415	240

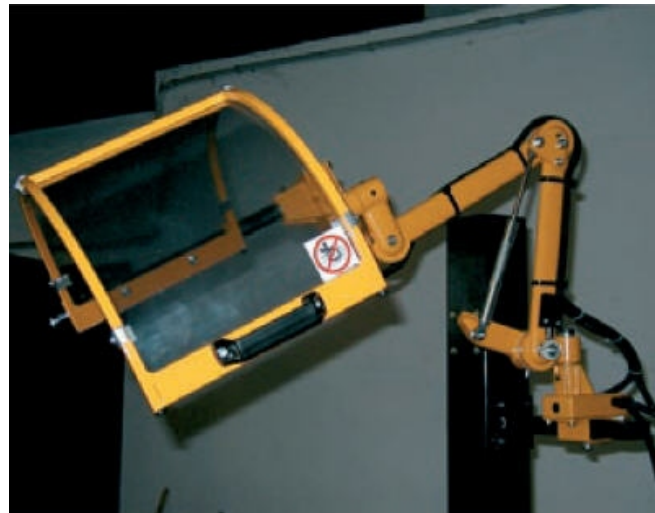
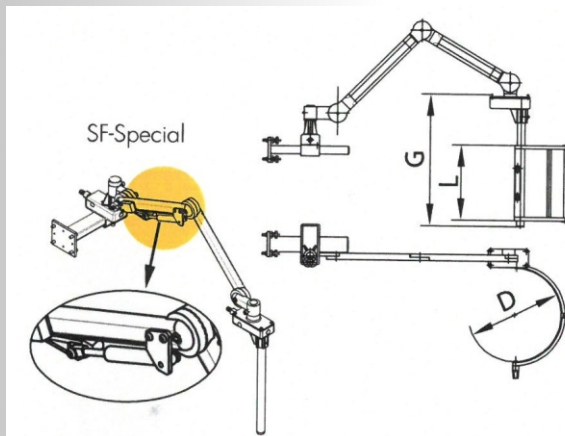

JOHTO/SYÖTTÖRUUVIN SUOJAT

- neopren tai nomexnauhalla
- korkeudet 160/200/250mm
- vakiopituudet 1200/1600/3000/3600mm
- muut mitat erikoistilauksena
- koteloitu malli

160/1200
200/1600
250/3000
250/3600

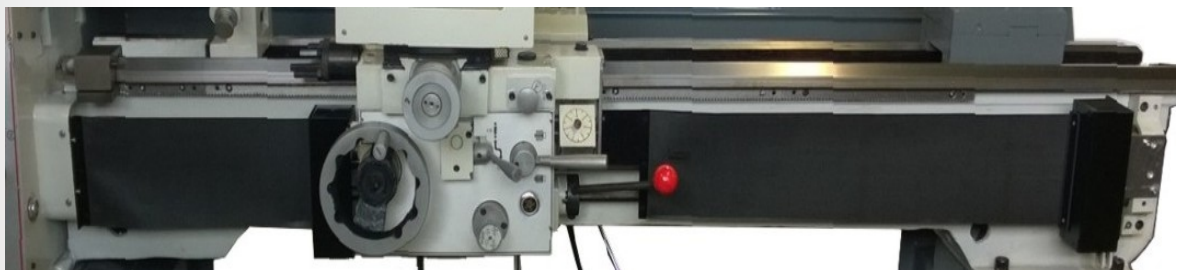
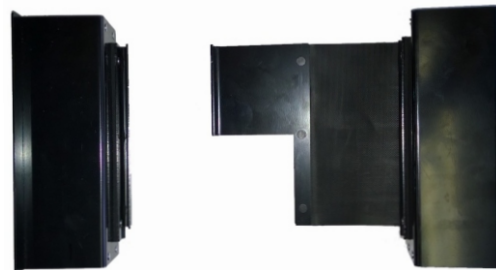

SUOJALAITTEET TYÖSTÖKONEISIIN



SORVIN ISTUKAN SUOJAT

- metallirungolla
 - läpinäkyvällä polykarbonaattisuojaalla
 - rajakytkimellä
- K: MT/koko

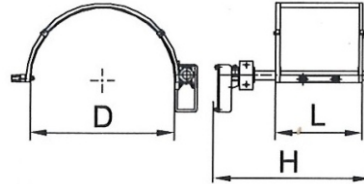

Koodi	MT/300	MT/350	MT/400	MT/450	MT/500	MT/600
D	300	350	400	450	500	600
L	240	240	240	240	240	240
H	415	415	415	415	415	415



- karalaatikon päälle asennettava malli
 - rajakytkimellä
- K: TS1 ja TS2

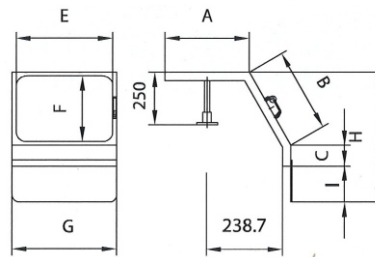

Koodi	A	B	C	E	F	G	I	H
TS1	360	265	120	450	225	500	170	530
TS2	400	400	100	450	360	500	170	615



KELKAN SUOJA

- metallirungolla
 - läpinäkyvällä polykarbonaattisuojaalla
 - rajakytkimellä
- K: CT1, CT1L, CT2 ja CT2L

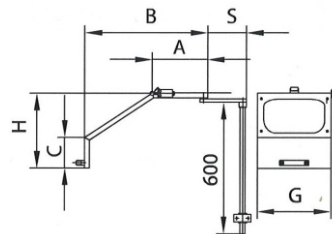

Koodi	A	B	C	G	H	S
CT1	200	400	100	300	320	200
CT1L	200	400	100	300	320	200
CT2	260	580	150	350	370	250
CT2L	260	580	150	350	370	250



TYÖVALOT



8000-062

-magn. jalalla
-taipuvalla 400mm varrella



8000-0062L

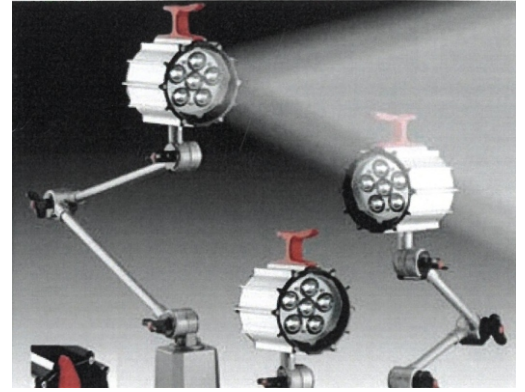

LA2

tyyppi	jännite	teho	valoteho	paino	Hinta
8000-0062	230V/12V	20W/halo	350lm	1,6kg	75:-
8000-0062L	230V/12V	6W/led	540lm	1,6kg	120:-
LA2	24V	6W/led	540lm		325:-



XP



PORANTEROITUSKONEET

XP

-230V/50Hz
-3,0-13mm
-teräkulma 118 astetta
-tekee myös kärkiohennukset
-made in USA
K:DDXPI



750X

750X

-230V/50Hz
-2,5-19mm
-teräkulmat 115-140 astetta
-tekee myös kärkiohennukset
-kangassalkussa
-made in USA
K:DD750XIBM



Lisävarusteena:

-timanttihiomakivi k100 ja 180
K:DA31325GF ja DA31320GF

-istukka vasenkätisille terille
K:DA02105PF

NESTEPUMPUPUT



Tyyppi	Teho	Jännite	Imusyvyys	Sarake1
120	60W	230V	60mm	
121	60W	230V	85mm	
122	60W	230V	120mm	
123	60W	230V	150mm	
220	180W	400V	200mm	
221	180W	400V	260mm	
222	250W	400V	200mm	
223	250W	400V	260mm	
226	120W	400V	120mm	
227	120W	400V	90mm	
228	120W	400V	120mm	
229	120W	400V	200mm	

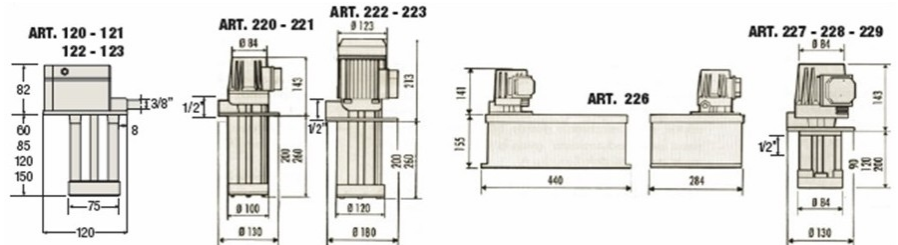

ART. 120-121-122-123

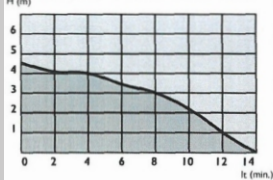

ART. 220 - 221

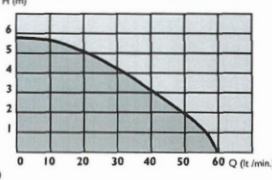

ART. 222 - 223

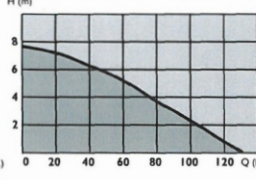

ART. 226

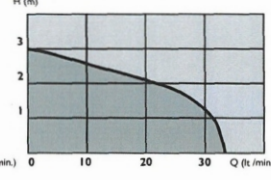

ART. 227 - 228 - 229

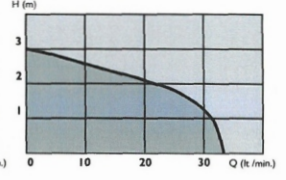

Hiomakivi	Väri	Karkeus	Sarake1
150x20x16/12/12,7mm	harmaa	36	
150x20x16/12/12,7mm	harmaa	60	
150x20x32mm	valkoinen	60	
150x25x32mm	harmaa	46	
150x25x32mm	valkoinen	60	
200x20x16mm	harmaa	36	
200x20x16mm	harmaa	60	
200x20x32mm	valkoinen	60	
200x20x32mm	vihreä	120	
200x25x20mm	harmaa	36	
200x25x20mm	harmaa	60	
200x25x32mm	valk.	60	
200x25x32mm	vihreä	120	
200x30x32mm	harmaa	36	
200x30x32mm	harmaa	60	
200x32x32mm	valkoinen	60	
250x40x32mm	harmaa	36	
250x40x32mm	harmaa	60	
250x40x32mm	harmaa	80	

KERAAMISET HIOMAKIVET



Tahkon kivi	Väri	Karkeus	Hinta
180x30x20mm	harmaa	150	
200x40x20mm	harmaa	150	
250x50x22mm	valkoinen	150	

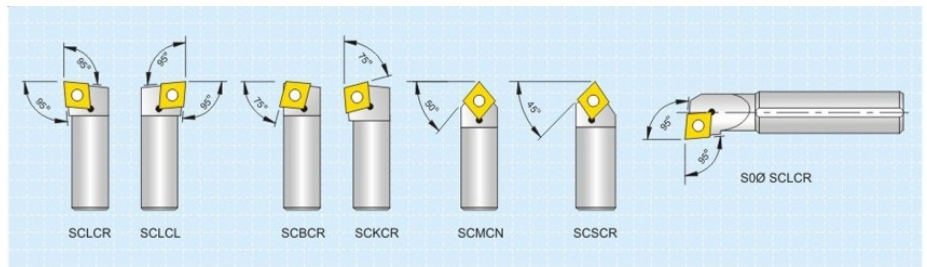

SORVIN TERÄSARJA 7 os.

- kovam. vaihtopaloilla (8,10 ja 12mm CCMT06 ja 16mm CCMT09)
- 6 kpl ulkoterävarsia + 1 kpl sisäterävarsi (varsi astetta pienempi kuin ulkovarsi)
- sarja sisältää teräpalat
- muovilaukussa
- 8mm, 10mm, 12mm, 16mm, 20mm ja 25mm terävarsilla

Tyyppi	Ulkovarsi	Hinta
777102	8mm	185:-
777103	10mm	185:-
777104	12mm	185:-
777106	16mm	255:-
777107	20mm	330:-
777108	25mm	359:-

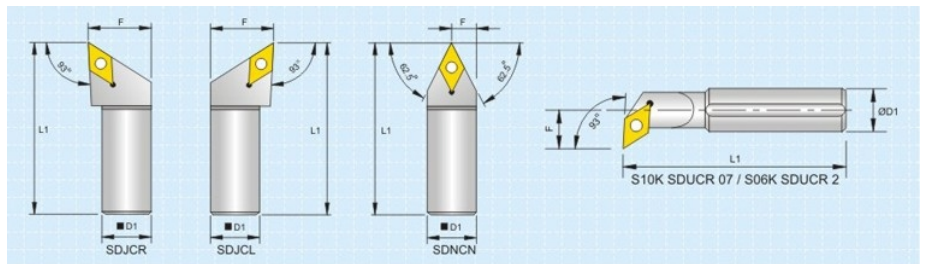
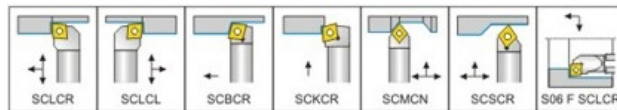

SORVIN TERÄSARJA 4 os.

- kovam. vaihtopaloilla (DCMT)
- 3 kpl ulkoterävarsia
- 1 kpl sisäterävarsi (sama koko kuin ulkovarsi)
- sarja sisältää teräpalat
- muovilaukussa
- 12mm tai 16mm terävarsilla
- K:777202 (12mm), 777203 (16mm)

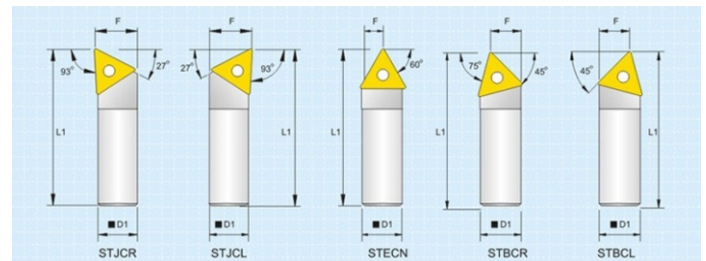
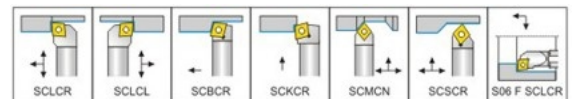

SORVIN TERÄSARJA 5 os.

- kovam. vaihtopaloilla (TCMT)
- 5 kpl ulkoterävarsia
- sarja sisältää teräpalat
- muovilaukussa
- 12mm tai 16mm terävarsilla
- K:777304 (12mm), 777305 (16mm)

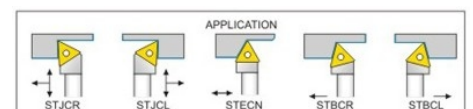



SORVIN SISÄSORVAUSTERÄSARJA

- kovam. vaihtopaloilla (CCMT06)
 - 8, 10, 12 ja 16mm terävarret (SCLCR)
 - teräpaloilla
 - jäähdytysnestekanavalla
 - muovilaukussa
- K:780400

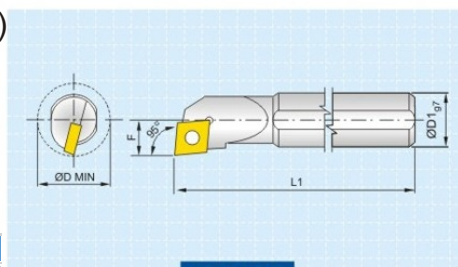

S-SCLCR (Right Hand Shown)

Tyyppi	D1	L1	F	D min.
A08H SCLCR 06	8	100	6	10
A10J SCLCR 06	10	110	7	13
A12K SCLCR 06	12	125	9	16
A16M SCLCR 06	16	150	11	20



- kovam. vaihtopaloilla (CCMT09)
 - 12, 16 ja 20mm terävarret (SCLCR)
 - teräpaloilla
 - muovilaukussa
- K:780410

Tyyppi	D1	L1	F	D min.
S12M SCLCR 09	12	150	9	16
S16R SCLCR 09	16	200	11	20
S20S SCLCR 09	20	250	13	25

KATKAISUTERÄPIDIN

- hss lehdellä
- co 5%



Tyyppi	pidin	lehti
392665	8mm	2x10x100mm
392675	10mm	2,4x13x112mm
392685	12mm	3,1x19x150mm

KATKAISUTERÄPIDIN

- kovam. palalla
- ruuvikiinnitteinen

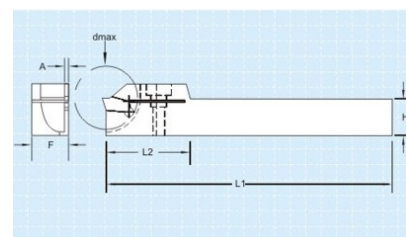

Tyyppi	L1	L2	A	F	dmax	B	H	Malli
775005	125	28	2	10	25,4	12	12	CGGCR 1212 K02
775010	125	35	2	16	25,4	16	16	CGGCR 1616 K02

KATKAISUTERÄPIDIN

- kovam. palalla ja syvyyssäädettävällä lehdellä

tyyppi	pidinkork.	lehti	teräpala
776020	8mm	20mm	2mm
776030	10mm	20mm	2mm
776035	12mm	20mm	2mm
776045	16mm	20mm	2mm
776050	20mm	25mm	3mm
776055	20mm	32mm	3mm





TERÄPITIMET KIERTEITYKSEEN

- ulko SER 1010 K:775100
- ulko SER1212 K:775110
- ulko SER 1616 K:775120
- ulko SER 2020 K:775130

Teräpalat (SER1010 ja 1212) 700401
ja (SER 1616 ja 2020) 700411



- sisä SIR 0010 K:722100
- sisä SIR 0012 K:722110
- sisä SIR 0016 K:722120
- sisä SIR 0020 K:722130

Teräpalat (SIR 0010 ja 0012) 700381
ja (SIR 0016 ja 0020) 700351

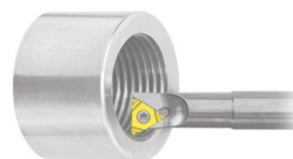

TERÄT KIERTEYTYKSEEN, pr

- juotetulla kovametallipalalla
- terävärsi 12x12mm
- sisältää 55 ja 60 asteisen terän
- sisäsarja K:13138
- ulkosarja K:131393

SORVIN SÄÄSTÖTERÄT HSS CO 10%

- 6x6x100mm Co 5% K:131950
- 6x6x160mm Co 10% K:0642006160
- 8x8x100mm Co 5% K:131965
- 8x8x160mm Co 10% K:0642008160
- 10x10x100mm Co 5% K:131980
- 10x10x160mm Co 10% K:0642010160
- 12x12x100mm Co 5% K:131995
- 12x12x160mm Co 10% K:0642012160



TERÄPITIMET ULKOSORVAUKSEEN

- SCLCL/R 0808 D6 K:773233 ja 773234
- SCLCR/L 1010 E06 K:773235 ja 773236
- SCLCR/L 1212 F06 K:773237 ja 773238
- SCLCR/L 1212 F09 K:773239 ja 773240
- SCLCR/L 1616 H09 K:773243 ja 773244
- SCLCR/L 2020 K09 K:773245 ja 773246



TERÄPITIMET SISÄSORVAUKSEEN

- S06F SCLCR 06 K:720921
- S08H SCLCR 06 K:720923
- S10K SCLCR 06 K:720925
- S12M SCLCR 09 K:720941
- S16R SCLCR 09 K:720943
- S20S SCLCR 09 K:720945



KIERTEITYSISTUKAT

- MK1 M3-M6 K:140010
- MK2 M3-M12 K:140020
- MK3 M10-M20 K:140030
- momentilla
- suunnanvaihdolla
- istukka, kts.kuva

1. Kara
- 2-3. Momentin säätö
- 4-5. Kehrän runko
6. Runko
7. Hammaspyörät
8. Karatappi
- 9-10 Kytkin
11. Voitelunippa
12. Ohjain
13. Kara
14. Ruuvilukitus kierretapeille
15. Istukan laippa
16. Istukan leuat

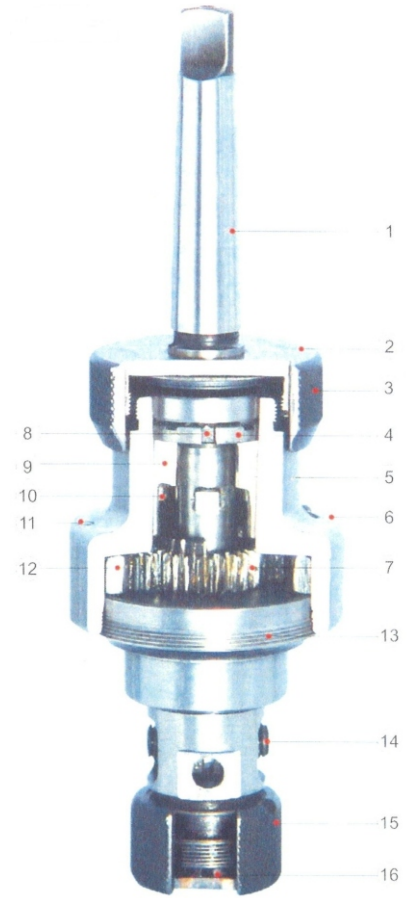

HIOMAKIVEN OIKAISUTIMANTTI

- 0,75 kar
- 12,7 x 125mm
- K:120115



391110



391300

PYÄLLYSKEHRÄT

Tyyppi	Varsikoko	Kehrien koko	Karkeus
391110	12,7x12,7x112	19x9,5x6,35	Medium
391300	12,7x12,7x125	19x6,3x6,35	Fine&Medium

KESKIÖPORAT HSS-G

- 2,0mm/5mm K:011100200
- 2,5mm/6,3mm K:011100250
- 3,15mm/8mm K:011100315
- 4,0mm/10mm K:011100400
- 5,0mm/12,5mm K:011100500





KULMAJYRSIN
-20mm tai 25mm, varsi 16mm
-3:lla CCMT 06 palalla

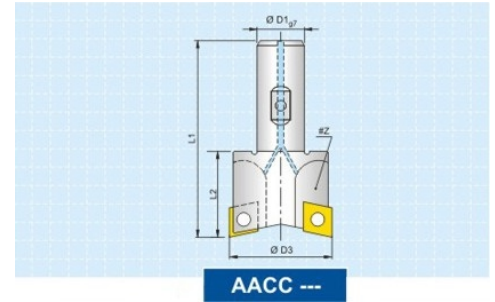

Tyyppi	D3	D1	L1	L2	Z	Teräpala	Malli	Sarake 1
750420	20	16	75	32	3	CCMT 0602	AACC 2016 06	
750425	25	16	75	32	3	CCMT 0602	AACC 2516 06	



KULMAJYRSIN
-40mm (D3), 16mm kara (D1), 4 palalla
-50mm (D3), 22mm kara (D1), 5 palalla
-63mm (D3), 22mm kara (D1), 6 palalla
-muovilaatikossa
-sarja sisältää palat (APKT)
K:773250 (40mm)
773260 (50mm)
773270 (63mm)

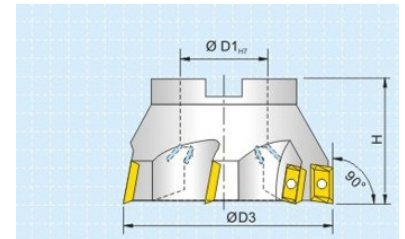

JYRSINTUURNAT
-combimalli
-MK2/16mm
-MK3/22mm (vetok. M12)
-MK4/22mm (vetok. M16)
-ISO30/22mm
-ISO40/22mm



VARSIJYRSINSARJAT
-3-12mm
-poraava
-weldon
-hss co 8%
-4-leikkuinen
-3,4,6,8,10 ja 12mm
K:VAR3-12

INECO



-3-20mm
-poraava
-weldon
-hss co 8%
-4-leikkuinen
-3,4,5,6,8,10,12,14,16,18 ja 20mm

K:VAR3-20

NÄYTTÖLAITE MITTASAUVALLE

- tukevalla alumiinirungolla
- digitaalinäytöllä, resoluutio 0,005mm
- metrinen/tuumanen näyttö
- laskin, linjajako, reikäpiirijako, keskitys...
- kahdelle/kolmelle sauvalle
- sorvikäyttöön oma malli
- toimitetaan kiinnitysvarren kanssa
- laatustandardin ISO 9002 mukainen



MITTASAUVAT

- helppo asennettavuus esim. sorviin, jysinkoneeseen jne.
- resoluutio 0,001/0,005mm
- suojaus DIN 40050 IP53
- lukupää viidellä laakerointipisteellä sauvarunkoon
- laatustandardin ISO 9002 mukainen
- sauvamitat 150, 200, 250, 300, 350, 400, 450, 500, 550, 600, 650, 800, 1000, 1100, 1200, 1300, 1400, 1500 ja 2000mm



- Easson mittasauvoissa on alumiinikotelo, joka suojaa sauvaa, lukupäätä ja johdepintoja likaa ja nesteitä vastaan.
- lisäksi mukana toimitetaan erillinen suojakaari joka suojaa mittasauvaa iskulta.

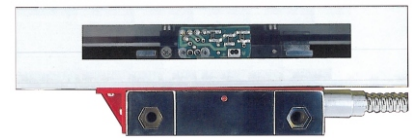

- lukupää on suojattu kaksinkertaisella kumitiivisteellä, suojausluokka IP 53.

Biga



METALLISORVIN/JYRSINKONEEN DIGITAALINEN NÄYTTÖLAITE MITTASAUVOILLA

- näyttölaite BC 20 (alumiinirunko)
- sarja sisältää kaksi tai kolme mittasauvaa 100-1000mm
- resoluutio 0,001/0,005mm
- lukupää viidellä laakerointipisteellä
- mittasauvat alumiinirungolla
- 3m kaapeli (sauvoissa)
- suojausluokka IP 54
- Sarja sisältää alumiiniset asennuspalat

MITTAKELLON JALKA

- magneettikiinn. 60kg
- hienosäädöllä
- K: MJALKA

**MITTAKELLO**

- näyttötarkkuus 0,01mm
- 58mm taulu (B)
- näyttöliike (A) 10mm
- K: MKELLO

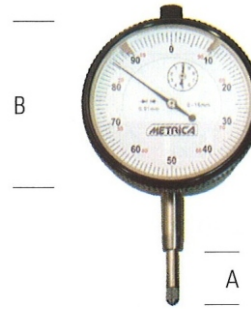
**TYÖNTÖMITAT**

- muovilaaatikossa
- 0-150mm digit.
- 0-200mm digit.
- 0-300mm digit.
- K: 06039-koko

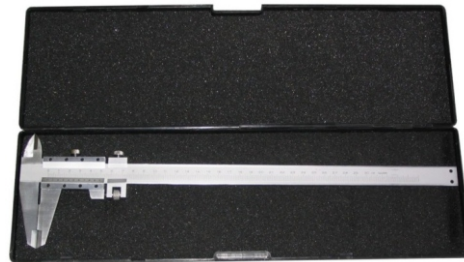

- autolock, tarkkuus 0,02mm
- 0-150mm
- 0-300mm

**MIKROMETRIT**

- 0-25mm 15,90
- 25-50mm 17,90
- K: 06051K ja 06051K-50

**RAKOTULKKI**

- 13 lehtinen
- 0,05-1,00mm
- K: 978213





VANNESAHAN TERÄT M42, CO 8%

BG-1140				791			
Z8/12	1140x13x0,65			Z4/6	2000x19x0,9		
Z14	1140x13x0,65			Z6/10	2000x19x0,9		
Z18	1140x13x0,65			Z14	2000x19x0,9		
ABS 105, 780, 780 XL, 782 XL, 783 XL				792, 2200 XL, 2200DA XL, 2201 XL, 787 XL, N216 XL			
Z6	1335x13x0,65			Z4/6	2140x19x0,9		
Z8/12	1335x13x0,65			Z6/10	2140x19x0,9		
Z14	1335x13x0,65			Z8/12	2140x19x0,9		
Z18	1335x13x0,65			Z14	2140x19x0,9		
784, 784 XL				Speeder 225SH			
Z6	1440x13x0,65			Z4/6	2265x19x0,9		
Z8/12	1440x13x0,65			Z6/10	2265x19x0,9		
Z14	1440x13x0,65			Z8/12	2265x19x0,9		
Z18	1440x13x0,65			Z10/14	2265x19x0,9		
120 NG, 120 NG XL, ABS NG120				Speeder 270SH, 275SH, 270DS, 275DS			
Z6	1440x13x0,65			Z4/6	2460x27x0,9		
Z8/12	1440x13x0,65			Z6/10	2460x27x0,9		
Z14	1440x13x0,65			Z8/12	2460x27x0,9		
Z18	1440x13x0,65			Z10/14	2460x27x0,9		
785, 785XL				795, 796			
Z6	1735x13x0,9			Z4/6	2465x19x0,9		
Z6/10	1735x13x0,9			Z6/10	2465x19x0,9		
Z14	1735x13x0,9			Z14	2465x19x0,9		
160 NG, ABS NG160				N266DA XL			
Z6	1735x13x0,9			Z4/6	2565x27x0,9		
Z6/10	1735x13x0,9			Z5/8	2565x27x0,9		
Z14	1735x13x0,9			Z6/10	2565x27x0,9		
1750XL, ABS 1750XL				Speeder 350DS			
Z4/6	1735x19x0,9			Z8/12	2565x27x0,9		
Z6/10	1735x19x0,9			Z10/14	2565x27x0,9		
Z8/12	1735x19x0,9			Z4/6	3160x27x0,9		
Z14	1735x19x0,9			Z5/8	3160x27x0,9		
				Z6/10	3160x27x0,9		
				Z8/12	3160x27x0,9		